



INT

VRT 220





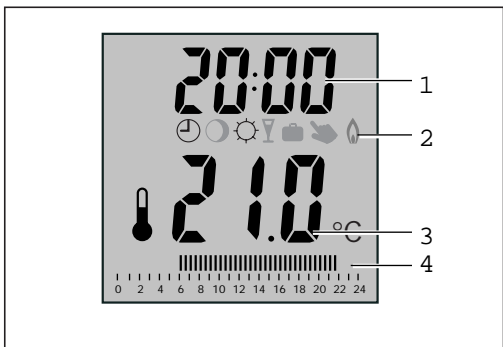
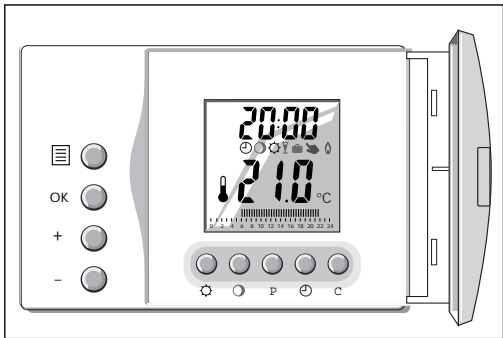

DE	Bedienung	4
	Montage	6
GB	Operating	8
	Montage	10
FR	Notice d'utilisation	12
	Notice de montage	14
ES	Manejo	16
	Montaje	18
IT	Uso	20
	Installazione	22
NL	Bediening	24
	Installatie	26
DK	Betjening	28
	Montage	30
PL	Obsługa	32
	Montaż	34
HU	Kezelés	36
	Szerelés	38
CZ	Návod k obsluze	40
	Návod k montáži	42
RO	Exploatare	44
	Instalare	46
HR	Rukovanje	48
	Montaža	50
SK	Obsluha	52
	Montáž	54
TR	Kullanımı	56
	Montajı	58
RUS	Эксплуатация	60
	Монтаж	62









Bedienung

Lassen Sie in dem Zimmer, indem sich Ihr Raumtemperaturregler befindet, stets alle Heizkörperventile voll geöffnet.

Bedienelemente

-  Betriebsart wählen
- OK Wert bestätigen, weiterblättern
- + Wert erhöhen
- Wert verringern
-  Tagtemperatur einstellen/wählen
-  Absenkttemperatur einstellen/wählen
- P Heizzeiten programmieren
-  Uhrzeit einstellen
- C Zurück springen/Wert rücksetzen

Display Übersicht

- 1 Aktuelle Uhrzeit
- 2 Symbole
 -  Die Raumtemperatur wird vom eingegebenen Programm geregelt.
 -   - Absenktzeit
 -   - Heizzeit
 -  Ständige Regelung der Raumtemperatur entsprechend der Absenkttemperatur.
 -  Ständige Regelung der Raumtemperatur entsprechend der Tagtemperatur.

▼ Partyfunktion: Bis zur nächsten Absenkezeit wird die Raumtemperatur entsprechend der Tagtemperatur geregelt.

🗄️ Ferienprogramm: Für die Dauer Ihres Urlaubs wird die Raumtemperatur entsprechend der eingestellten Temperatur geregelt.

👉 Kurzfristige Temperaturveränderung

🔥 Wärmeanforderung an das Heizgerät

3 Aktuelle Temperatur

4 Balkenanzeige (I = Heizzeit ein)

Beschreibung des Gerätes

Der VRT 220 ist ein Raumtemperaturregler mit Tages-Heizprogramm. Er ist verwendbar für alle Vaillant Wandheizgeräte, Vaillant Heizkessel und Fremdgeräte mit einer 230 V Schnittstelle.

Der Regler verfügt über ein einstellbares Programm zur Heizungsregelung.

Werkseinstellung

Heizzeit: 6:00-22:00 Uhr

Betriebsart wählen	64
Urlaubsfunktion aktivieren	66
Temperatur kurzfristig verstellen	68
Tag-/Absenktemperatur einstellen	70
Uhrzeit einstellen	72
Programm einstellen	74
Schalten über Telefonfernkontakt	76

Montage

Dieses Gerät darf nur von einem anerkannten Fachmann geöffnet und gemäß den Abbildungen der Seiten 78 bis 80 installiert werden. Dabei sind die bestehenden Sicherheitsvorschriften zu beachten.



Lebensgefahr durch Stromschlag an spannungsführenden Anschlüssen. Vor Arbeiten am Gerät die Stromzufuhr abschalten und vor Wiedereinschalten sichern.

Für Schäden, die durch Nichtbeachtung dieser Anleitung, insbesondere durch Fehlverdrahtung oder mechanische Beschädigung entstehen, übernehmen wir keine Haftung.

Telefonfernschalter (TEL) anschließen

Der Telefonfernschalter wird an den Klemmen 5 und TEL des Reglers angeschlossen (siehe Abbildung Seite 80). Bitte beachten Sie die Installationsanleitung des Telefonfernschalters.





Technische Daten

Gerätebezeichnung	VRT 220
Betriebsspannung	230 V~
Stromaufnahme	< 3mA
max. Kontaktbelastung	5 A/250 V~ $\cos \varphi=1$
Gangreserve Uhr	0,5 h
Tagtemperaturbereich	5 ... 30°C
Absenkttemperaturbereich	5 ... 20°C
Schaltdifferenz	$\leq 1K$
Anschlussleitungen	3x0,75 mm ²
Schutzart	IP 30
Schutzklasse	II
Betriebstemperatur	+ 5 ... + 50 °C
Zul. Lagertemperatur	- 20 ... + 65 °C
Abmessungen	111 x 81 x 33 mm
Eingang TEL aktiv	230 V~







1 Operating

Ensure that all the regulating valves are fully opened on the radiators located in the same room as the room-temperature control device.

Operating elements

-  Choose operating mode
- OK Confirm a value, continue
- + Raise a value
- Reduce a value
-  Adjust/Choose day temperature
-  Adjust/Choose night temperature
- P Set heating periods
-  Set date and time
- C Undo / Return

Display, Overview

- 1 Actual time
- 2 Symbols
 -  The room temperature is controlled by the pre-set program.
 -   - "Reduce" setting
 -   - Heating setting
 -  The room temperature is permanently controlled according to the reduced (night) temperature.
 -  The room temperature is permanently controlled according to the day temperature.

- 📉 Override mode: The room temperature is controlled according to the day temperature until the next reduce setting.
- 📅 Holiday program: during the holidays the room temperature is controlled according to the adjusted "reduced" temperature.
- 👉 Temporarily change of the temperature
- 🔥 Heating demand to the boiler

3 Actual temperature

4 Heating indicator (I = Heating period on)

Device description

VRT 220 is a programmable roomthermostat.

They can be connected with all Vaillant boilers and outside boilers with 230 V thermostat input.

The thermostat already carries out a sensible heating programme:

Pre-set values

Heating period 6.00 ... 22.00

Choose the operating mode	64
Activate the holiday program	66
Temporary change of temperature setting ...	68
Adjust the day/night temperature	70
Set the time	72
Set program	74
Connect with remote-control switch	76

2 Installation

This system **MUST** be fitted by a qualified and approved installation engineer, proceeding as shown on pages 78 to 80. The relevant safety guidelines should be followed at all times.



There is a danger of fatal injury from touching live components. Always shut off the power supply to the system (and ensure it cannot be reconnected) BEFORE carrying out installation or maintenance work.

Note that we will accept no liability whatsoever for injury or damage resulting from failure to observe these instructions. This condition applies especially to incorrect wiring and/or defective mechanical installation.

Connect a remote-control switch (TEL) (not currently available in the UK)

The remote-control switch is connected on terminal 5 and TEL (see page 80).

Please note the installations instructions of the remote-control switch.





Technical specifications

Device type	VRT 220
Operating voltage	230 V~
Power consumption	< 3mA
Max. contact load	5 A/250 V~ $\cos \varphi=1$
Power reserve	0,5 h
Day temperature range	5 ... 30°C
Night temperature range	5 ... 20°C
Switching difference	$\leq 1K$
Connection leads	3x0,75 mm ²
Protection rating	IP 30
Protection classification	II
Operating temperature	+ 5 ... + 50 °C
Permitted storage temp.	- 20 ... + 65 °C
Dimensions	111 x 81 x 33 mm
input terminal TEL active	230 V~







Utilisation

Laissez toujours tous les robinets des radiateurs complètement ouverts dans la pièce où se trouve votre thermostat d'ambiance.

Organes de commande

-  Sélectionner le mode de fonctionnement
- OK Confirmer la valeur, avancer dans le programme
- + Augmenter la valeur
- Abaisser la valeur
-  Régler/Chiosir la température jour
-  Régler/Chiosir la température nocturne
- P Programmer les heures de chauffage
-  Régler les heures et jours de semaine
- C Revenir en arrière/Restituer la valeur

Vue d'ensemble de l'écran

- 1 Heure actuelle
- 2 Symboles
 -  La température ambiante est régulée par le programme sélectionné.
 -   - Période d'abaissement
 -   - Période de chauffe
 -  Régulation permanente de la température ambiante en fonction de la température d'abaissement.
 -  Régulation permanente de la température ambiante en fonction de la température jour

- ▼ Fonction party : la température ambiante est réglée en fonction de la température jour jusqu'à la prochaine période d'abaissement.
- 📅 Programme congés : la température ambiante est réglée en fonction de la température demandée pour la durée de vos vacances.
- 👉 Brève modification de température
- 🔥 Demande chauffage à l'appareil

Description de l'appareil

Le VRT 220 est un thermostat d'ambiance avec programmation journalière du chauffage.

On peut l'utiliser avec tous les appareils de chauffage Vaillant et les autres appareils (230V).

Le thermostat dispose d'un programme modifiable

Réglés d'usine:

période de chauffe: 6:00-22:00 heures.

Choix du mode de fonctionnement	64
Activer la fonction congés	66
Brève modification de la température	68
Réglage de la température jour/d'abaissement	.70
Réglage heure	72
Réglage du programme	74
Enclenchement par téléphone	76

Montage

Cet appareil ne peut être ouvert et installé que par un professionnel qualifié conformément aux schémas des pages 78 à 80 . Il convient, à cet effet de respecter les consignes de sécurité existantes.

Danger d'électrocution sur les raccordements conducteurs de courant. Avant les travaux sur l'appareil, couper l'alimentation secteur et mettre des coupe-circuits avant la remise en marche.

Nous ne sommes pas responsables des dommages pouvant découler du non-respect de ce mode d'emploi, des câblages défectueux ou détériorations mécaniques.

Raccordement du commutateur téléphonique à distance (TEL)

Le commutateur est raccordé sur les bornes 5 et TEL de la régulation (voir schéma page 80) Merci de suivre la notice d'installation du commutateur téléphonique.





Données techniques

Type d'appareil	VRT 220
Tension de fonctionnement	230 V~
Puissance absorbée	< 3mA
Charge de contact max.	5 A/250 V~ $\cos \varphi=1$
Réserve de marche	0,5 h
Plage de température jour	5 ... 30°C
Plage de temp. d'abaissement	5 ... 20°C
Différence de commutation	$\leq 1K$
Câbles de raccordement	3x0,75 mm ²
Type de protection	IP 30
Classe de protection	II
Temp. de fonctionnement	+ 5 ... + 50 °C
Temp. stockage admise	- 20 ... + 65 °C
Dimensions	111 x 81 x 33 mm
Entrée TEL active	230 V~







Manejo

En la habitación en la que se encuentre su regulador de temperatura, hay que dejar siempre completamente abiertas todas las válvulas del radiador

Elementos de mando

-  Seleccionar modo de funcionamiento
- OK Confirmar valor, pasar página
- + Aumentar valor
- Disminuir valor
-  Ajustar/seleccionar temperatura diurna
-  Ajustar/seleccionar descenso temperatura
- P Programar períodos calentamiento
-  Ajustar tiempo horario
- C Retroceder/ restaurar valor

Visión de conjunto del visualizador

- 1 Tiempo horario actual
- 2 Símbolos
 -  La temperatura ambiente es regulada por el programa vigente
 -   - período de descenso
 -   - período de calentamiento
 -  Regulación constante de la temperatura ambiente, de acuerdo con el descenso de temperatura
 -  Regulación constante de la temperatura ambiente, según la temperatura diurna.

📉 Función para guateque: hasta el próximo período de descenso, la temperatura es regulada de acuerdo con la temperatura diurna.

📅 Programa para vacaciones: Mientras duren sus vacaciones, la temperatura ambiental será regulada según la temperatura prefijada de antemano.

👉 Variación de la temperatura a corto plazo

🔥 Solicitud de calor al aparato de calefacción

3 Temperatura actual

4 Indicación de barra (I = tiempo de calentamiento, conectado)

Descripción del aparato

El VRT 220 es un termostato de ambiente, con programación diaria de calefacción. Puede utilizarse para todos los aparatos murales de calefacción de Vaillant, en la caldera de calefacción Vaillant y radiadores de otras marcas con un interfaz de 230 V.

De fábrica:

Períodos de calefacción De 6:00-22:00 horas

Seleccionar modo de funcionamiento	64
Activar funcionamiento en vacaciones	66
Variar temperatura a corto plazo	68
Ajustar la temperatura diurna	70
Ajustar el descenso de temperatura	70
Ajustar el tiempo horario	72
Ajustar el programa	74
Conectar por contacto telefónico a distancia .	76

Montaje

Este aparato sólo puede ser abierto e instalado según las figuras de la Página 98 a la Página 101 por un especialista cualificado. Para ello, habrán de tenerse en cuenta las normas de seguridad vigentes.



Peligro de muerte por descarga eléctrica en las conexiones sometidas a corriente. Antes de realizar trabajos en el aparato, desconectar la alimentación eléctrica y, antes de reconectar la corriente, fusiblear

No asumimos responsabilidad civil alguna por daños que puedan surgir por la inobservancia de las presentes instrucciones, en especial, por el cableado defectuoso, ni por desperfectos mecánicos que puedan surgir.

Conectar teleinterruptor telefónico (TEL)

El teleinterruptor telefónico se conecta a los bornes 5 y TEL del regulador (ver Figura, Página 80). Observe por favor, las instrucciones para la instalación del teleinterruptor telefónico.





Características técnicas

Denominación del aparato	VRT 220
Tensión de servicio	230 V~
Alimentación	< 3mA
Carga máxima de contacto	5 A/250 V~ $\cos \varphi=1$
Reserva de marcha	0,5 h
Gama de temperaturas diurnas	5 ... 30°C
Gama de descensos de temp.	5 ... 20°C
Diferencia de conmutación	$\leq 1K$
Cables de conexión	3x0,75 mm ²
Tipo de protección	IP 30
Clase de protección	II
Temperatura de servicio	+ 5 ... + 50 °C
Temp. de almacenaje admisible	- 20 ... + 65 °C
Dimensiones	111 x 81 x 33 mm
Entrada TEL act.:	220 V~







Utilizzo

Lasciate completamente aperte tutte le valvole dei caloriferi nella stanza in cui si trova il termostato.

Elementi d'uso

-  scegliere modo operativo
- OK confermare il valore, continuare a sfogliare
- + aumentare il valore
- diminuire il valore
-  scegliere/regolare la temperatura diurna
-  scegliere/regolare la temperatura attenuata
- P programmare i periodi di riscaldamento
-  regolare ora
- C tornare indietro/ ristabilire valori

Visualizzazione sul display

- 1 ora attuale
- 2 Simbole
 -  la temperatura ambiente viene regolata da un programma orario prestabilito
 -   - periodo di attenuazione
 -   - periodo di riscaldamento
 -  regolazione continua della temperatura ambiente attenuata
 -  regolazione continua della temperatura ambiente diurna

- ▼ funzione party: fino al successivo periodo di attenuazione, la temperatura ambiente viene regolata secondo l'impostazione diurna
 - 📅 programma ferie: per la durata della vostra assenza, la temperatura ambiente viene regolata secondo l'impostazione preferita
 - ➡ modifica immediata temperatura
 - 🔥 richiesta di calore dalla caldaia
- 3 temperatura attuale
 - 4 barra di segnalazione (I: periodo riscaldamento attivato)

Descrizione del prodotto

Il VRT 220 È un termostato ambiente con programma giornaliero di riscaldamento. E' installabile su tutte le caldaie Vaillant murali ed a basamento, nonché sulle caldaie della concorrenza aventi morsetti di allacciamento a 230 V.

Il termostato È disponibile con un programma

Periodi di riscaldamento: 6:00-22:00

scegliere il modo operativo	64
attivare la funzione ferie	66
variare immediatamente la temperatura	68
impostare la temperatura diurna	70
impostare la temperatura attenuata	70
inserire ora e giorno della settimana	72
impostare il programma	74
inserire il comando telefonico a distanza	76

Installazione

Installazione del termostato

Questi apparecchi devono essere aperti ed installati da un tecnico qualificato, secondo le figure da pag. 78 a pag. 80. Osservare le seguenti prescrizioni di sicurezza.



Pericolo di folgorazioni a causa di tensione presente nei cavi elettrici.

Prima di operare sull'apparecchio togliere la tensione ed assicurarsi che alla fine dei lavori venga riattivata.

Non rispondiamo dei danni causati dalla non osservanza di queste istruzioni.

Collegare il comando telefonico a distanza

Il comando telefonico a distanza viene collegato ai morsetti 5 e TEL del termostato (vedi fig. pag. 80) Per l'installazione e l'uso del comando telefonico a distanza, osservare le istruzioni ad esso allegate.





Dati Tecnici

Parametri	VRT 220
Tensione di funzionamento	230 V~
Corrente di inserimento	< 3mA
Carcio dei contatti mass	5 A/250 V~ $\cos \varphi=1$
Reserva di carica	0,5 h
Campo temperatura diurna	5 ... 30°C
Campo temperatura attenuata	5 ... 20°C
Differenza d'inserimento	$\leq 1K$
Cavi di collegamento	3x0,75 mm ²
Grado di protezione	IP 30
Classe di protezione	II
Temperatura di funzionamento	+ 5 ... + 50 °C
Temp. di stoccaggio ammessa	- 20 ... + 65 °C
Dimensioni	111 x 81 x 33 mm
Ingresso TEL aktiv	230 V~







Bediening

Zorg er voor dat in de ruimte waar de VRT 220 is gemonteerd altijd de radiatorkranen volledig zijn geopend.

Bedieningselementen

-  Bedrijfsfunctie kiezen
- OK Waarde bevestigen, doorbladeren
- + Waarde verhogen
- Waarde verlagen
-  Dagtemperatuur instellen/kiezen
-  Verlagingstemperatuur instellen/kiezen
- P Verwarmingsperioden programmeren
-  Tijd en dag instellen
- C Terugstappen/waarde corrigeren

Displayoverzicht

- 1 1 Actuele tijd
- 2 Symbolen
 -  Automatisch volgens geprogrammeerde perioden
 -   - Verlagingsperiode
 -   - Verwarmingsperiode
 -  Constante regeling volgens de ingestelde verlagingstemperatuur.
 -  Constante regeling volgens de ingestelde dagtemperatuur.

▼ Partyfunctie: tot de eerstvolgende verla-
gingsperiode wordt de temperatuur volgens
de ingestelde dagtemperatuur geregeld.

🧳 Vakantieprogramma: gedurende uw vakan-
tie wordt de kamertemperatuur volgens de
ingestelde temperatuur geregeld.

👉 Kortstondige temperatuurwijziging

🔥 Warmtevraag aan het CV-toestel

3 Actuele kamertemperatuur

4 Balkenaanwijzing (I = verwarming aan)

Productomschrijving

De VRT 220 is een aan/uit regelaar met een per dag programmeerbare schakelklok voor de besturing van een CV-toestel. De VRT 220 is toepasbaar op alle Vaillant ketels uit de nieuwe generatie met een 230 volt schakelingang met uitzondering van de hrSOLIDE.

De regelaar beschikt over een aan te passen pro-
gramma .

Fabrieksinstelling

verwarmingsperioden: 6:00-22:00 uur

Bediening	Pagina
Bedrijfsfunctie kiezen	64
Vakantieprogramma activeren	66
Kamertemperatuur kortstondig wijzigen	68
Dag-/Verlagingstemperatuur instellen	70
Tijd instellen	72
Programma instellen	74
Inschakelen op afstand via de telefoon	76

Installatie

Dit product mag alleen door een deskundige installateur worden geopend en volgens de afbeeldingen van pagina 78 tot 80 worden gemonteerd.

Hiervoor moeten de bestaande veiligheidsvoorschriften in acht worden genomen.



Levensgevaar door elektrocutie van onder spanning staande delen.

Bij werkzaamheden aan het toestel altijd de stroomtoevoer afsluiten en beveiligen tegen ongeoorloofd/per ongeluk weer inschakelen.

Voor schade die voortvloedt uit het niet opvolgen van de aanwijzingen uit deze handleiding en in het bijzonder schade ontstaan door het fout aansluiten van de bedrading of mechanische beschadiging zijn wij niet aansprakelijk.

Telefoonafstandsbediening aansluiten (n.v.t. in NL)

De telefoon afstandbediening wordt aangesloten aan de klemmen 5 en TEL van de regelaar (zie afbeelding pagina 80) Volg de aanwijzingen op uit de installatiehandleiding van de telefoonafstandsbediening.





Technische gegevens

Productbenaming	VRT 220
Bedrijfsspanning regelaar	230 V~
Opgenomen vermogen	< 3mA
Max. contactbelasting	5 A/250 V~ $\cos \varphi=1$
Gangreserve	0,5 h
Dagtemperatuur	5 ... 30°C
Verlagingstemperatuur	5 ... 20°C
Schakelverschil	$\leq 1K$
Doorsnede van de aansluitleidingen	3x0,75 mm ²
Beschermingssoort	IP 30
Beschermingsklasse	II
Bedrijfstemperatuur	+ 5 ... + 50 °C
Max. toelaatbare opslagtemperatuur	- 20 ... + 65 °C
Afmetingen (lxbxd)	111 x 81 x 33 mm
Ingang TEL actief:	230 V~







Betjening

Alle radiatortermostater i rummet, hvor rumtermostaten befinder sig, skal være helt åbne hele tiden.

Betjeningselementer

-  Valg af driftsart
- OK Acceptér værdi, bladre videre
- + Forhøje værdi
- Reducere værdi
-  Indstilling/valg af dagtemperatur
-  Indstilling/valg af nattemperatur
- P Programmering af opvarmningsperioder
-  Indstilling af klokkeslæt
- C Skridt tilbage/annullér værdi

Display oversigt

- 1 Aktuelt klokkeslæt
- 2 Symboler
 -  Rumtemperaturen styres af et program.
 -   - Nattemperatur/natsænkning.
 -   - Dagtemperatur.
 -  Rumtemperaturen styres af den indstillede nattemperatur.
 -  Rumtemperaturen styres af den indstillede dagtemperatur.

- ▼ Party-funktion: Indtil næste sænkingsperiode (nattemperatur) styres rumtemperaturen efter dagtemperatur.
- 📅 Ferie-program: Rumtemperaturen styres af den indstillede temperatur i ferie-perioden
- 👉 Midlertidig ændring af temperatur
- 🔥 Varmekrav fra gaskedlen

3 Aktuel temperatur

4 Bjælkevisning (I = varmeperiode til)

Beskrivelse af rumtermostaten

VRT 220 er en rumtermostat med dagprogram og kan anvendes til alle væghængte gaskedler fra Vaillant samt alle stående gaskedler fra Vaillant. Desuden kan den også anvendes til andre kedler med 230V tilslutning. Rumtermostaten har et regulerbart program.

Fabriksindstilling:

Varmeperioder : 6:00-22:00

Valg af driftsart64
Aktivering af feriedrift66
Midlertidig ændring af temperatur68
Indstilling af dagtemperatur / nattemperatur	.70
Indstilling af klokkeslæt72
Indstilling af program74
Styring via telefon76

Montage

Installation af rumtermostaten, funkmodtageren

Nærværende rumtermostat må kun åbnes af en autoriseret installatør, som installerer den i henhold til skitserne på side 78 til 80. Herved skal de gældende sikkerhedsregler overholdes.



Livsfare på grund af elektriske stød på spændingsførende tilslutninger. Før der udføres arbejde på anlægget, skal strømmen slås fra og sikres mod genindkobling.

Vaillant påtager sig ikke ansvaret for skader, der opstår ved at nærværende vejledning ikke følges; dette gælder især forkert el-installation eller beskadigelse af mekanikken.

Tilslutning af telefonstyring (TEL)

Telefonstyringen tilsluttes på klemmerne 5 og TEL på styringen (se fig. på side 80). Installationen foretages som beskrevet i den tilhørende vejledning.





Tekniske data

Apparattype	VRT 220
Driftsspænding	230 V~
Strømforbrug	< 3mA
Maks. kontaktbelastning	5 A/250 V~ $\cos \varphi=1$
Gangreserve	0,5 h
Dagtemperatur-område	5 ... 30°C
Nattemperatur-område	5 ... 20°C
Kontaktdifference	$\leq 1K$
Tilslutningsledninger	3x0,75 mm ²
Beskyttelsesgrad	IP 30
Beskyttelsesklasse	II
Driftstemperatur	+ 5 ... + 50 °C
Tilladt opbevaringstemp.	- 20 ... + 65 °C
Mål	111 x 81 x 33 mm
Indgang TEL aktiv	230 V~







Obsługa

W pokoju, w którym znajduje się regulator temperatury, wszystkie zawory termostatyczne na grzejnikach powinny być całkowicie otwarte.

Elementy obsługi

-  Wybór rodzaju pracy
- OK Zatwierdzenie wartości, przejście dalej
- + Podwyższenie wartości
- Obniżenie wartości
-  Nastawienie / wybór temperatury dziennej
-  Nastawienie / wybór temperatury obniżonej
- P Programowanie okresów grzewczych
-  Nastawienie czasu zegara
- C Krok do tyłu / powrót do poprzedniej wartości

Wskaźniki na wyświetlaczu

- 1 Aktualny czas zegara
- 2 Symbole:
 -  Temperatura pomieszczenia regulowana jest przez ustawiony program
 -   - Temperatura pomieszczenia obniżona
 -   - Temperatura pomieszczenia dzienna
 -  Obniżona temperatura pomieszczenia na stałe
 -  Dzienna temperatura pomieszczenia na stałe

- ▼ Funkcja "Party": podwyższenie temperatury pomieszczenia najbliższego okresu temperatury obniżonej
 - 📅 Program wakacyjny: W okresie urlopu temperatura pomieszczenia będzie regulowana odpowiednio do zadanej wartości .
 - 👉 Krótkotrwała zmiana temperatury
 - 🔥 Żądanie ciepła przez obieg grzewczy C.O.
- 3 Aktualna temperatura pomieszczenia
 - 4 Wskaźnik kreskowy (I = przedział grzania)

Opis regulatora

VRT 220 240 jest pokojowym regulatorem temperatury z dobowym programem ogrzewania. Może być zainstalowany do wszystkich wiszących kotłów centralnego ogrzewania firmy Vaillant i kotłów innych producentów. Napięcie zasilania 220-230 V. Regulator posiada jeden ustawialny program dla centralnego ogrzewania.

Okresy: Czas grzania 6:00-22:00

Wybór trybu pracy	64
Aktywacja funkcji urlopowej	66
Krótkotrwałe przestawienie temperatury	68
Ustawienie temperatury dziennej	70
Ustawienie temperatury obniżonej	70
Ustawienie godziny	72
Ustawienie programu	74
Przełączenie przez telefon	76

Montaż regulatora

Regulator może być otwierany i instalowany (zgodnie z rysunkami na stronach 78 do 80), tylko przez firmowego lub autoryzowanego serwisanta firmy Vaillant. Należy przestrzegać zasady bezpieczeństwa.



Niebezpieczeństwo dla życia przez porażenie prądem. Przed przystąpieniem do pracy odłączyć prąd elektryczny od urządzenia i zabezpieczyć przed przypadkowym włączeniem.

Za szkody powstałe w wyniku nie przestrzegania zasad podanych w niniejszej instrukcji, złych połączeń elektrycznych lub mechanicznych uszkodzeń, firma Vaillant nie ponosi odpowiedzialności.

Podłączenie zdalnego przełącznika

telefonicznego (TEL). Zdalny przełącznik telefoniczny jest podłączony do zacisku 5 i TEL regulatora (patrz rysunek na stronie 80). Należy przestrzegać zasady podane w instrukcji instalacyjnej zdalnego przełącznika telefonicznego





Techniczne dane

	VRT 220
Napięcie zasilania	230 V~
Pobór prądu	< 3mA
Maks, obciążenie styków	5 A/250 V~ $\cos \varphi=1$
Rezerwa zasilania	0,5 h
Zakres temperatury dziennej	5 ... 30°C
Zakres temperatury obniżonej	5 ... 20°C
Histereza	$\leq 1K$
Połączenie elektryczne	3x0,75 mm ²
Stopień ochrony	IP 30
Klasa ochrony	II
Temperatura pracy	+ 5 ... + 50 °C
Zakres temp. przechowywania	- 20 ... + 65 °C
Wymiary	111 x 81 x 33 mm
Podłączenie tel.: TEL	230 V~







Kezelés

Abban a helyiségben, ahol a szobahőmérséklet-szabályozó található, mindig tartsa nyitva az összes fűtőtest szelepét.

Kezelőelemek

-  Üzemmódkapcsoló
- OK Érték elfogadása, továbblapozás
- + Érték növelése
- Érték csökkentése
-  Nappali hőmérséklet beállítása/választása
-  Csökkentett hőmérséklet beállítása/választása
- P Fűtésidők programozása
-  Pontos idő beállítása
- C Visszalépés / érték törlése

Kijelző

- 1 Aktuális időpont
- 2 Szimbólumok
 -  A szobahőmérsékletet a megadott program szabályozza.
 -   - Csökkentett hőmérséklet ideje
 -   - Fűtés ideje
 -  Szobahőmérséklet folyamatos szabályozása a csökkentett hőmérsékletnek megfelelően
 -  Szobahőmérséklet folyamatos szabályozása a nappali hőmérsékletnek megfelelően

- ▼ Party-funkció: a következő csökkentési időig a szobahőmérsékletet a rendszer a nappali hőmérsékletnek megfelelően szabályozza
- 📅 Szabadság-program: szabadsága idején a rendszer a szobahőmérsékletet a beállított hőmérsékletnek megfelelően szabályozza
- 👉 Rövid idejű hőmérsékletváltozás
- 🔥 Fűtési hőigény

3 Aktuális hőmérséklet

4 Sávkijelzés (I = fűtési idő be kapcsolva)

Készülékleírás

A VRT 220 heti fűtési programot tartalmazó szabályozó. Minden Vaillant fali fűtőkészülékkel, Vaillant álló kazánnal és más gyártmányú 230 V jelszintű berendezésével együtt alkalmazható. A szabályozó két egy egyénileg beállítható programmal rendelkezik.

Gyári beállítás:

Fűtésidők 6:00 - 22:00

Üzem mód kiválasztása	64
Szabadság-funkciók aktiválása	66
Hőmérséklet módosítása rövid időre	68
Nappali hőmérséklet beállítása	70
"Csökkentett hőmérséklet" beállítása	70
A pontos idő beállítása	72
Program beállítása	74
Telefon kapcsolaton át kapcsolás	76

Szerelés

A szabályozó telepítése

A készüléket csak szakember nyithatja ki és szerelheti fel a 78 - 80 oldalak ábrái szerint. Ennek során be kell tartani az érvényes biztonsági előírásokat.



A feszültség alatt álló csatlakozó érintése életveszélyes. A készüléken végzett munka előtt kapcsoljuk le az áramellátást, és zárjuk ki az újrabekapcsolástól lehetőségét.

Az ezen útmutató figyelmen kívül hagyása, de különösen a hibás kábelezés vagy mechanikai sérülés miatt fellépő kártért felelősséget nem vállalunk.

Telefontávkapcsoló bekötése (TEL)

A telefontávkapcsolót a szabályozó 5 és TEL kapcsaira kell kötni (l. 80. oldalt). Kérjük, a telefontávkapcsoló szerelési útmutatóját is vegye figyelembe.





Műszaki adatok

Készülék típusa	VRT 220
Üzemi feszültség	230 V~
Áramfelvétel	< 3mA
Max. terhelés	5 A/250 V~ $\cos \varphi=1$
Menettartalék (óra)	0,5 h
Nappali hőmérséklet tartománya	5 ... 30°C
Csökkentett hőmérséklet tartománya	5 ... 20°C
Kapcsolási különbség	$\leq 1K$
Csatlakozó vezeték	3x0,75 mm ²
Védettség	IP 30
Védettségi osztály	II
Működési hőmérséklet	+ 5 ... + 50 °C
Tárolási hőmérséklet	- 20 ... + 65 °C
Méret	111 x 81 x 33 mm
Telefonérintkező aktív	230 V~







Návod k obsluze

V místnosti, kde se nachází prostorový regulátor teploty, nechte trvale otevřené ventily topných těles.

Ovládací prvky

-  volba druhu provozu
- OK potvrzení hodnoty, procházení
- + zvýšení hodnoty
- snížení hodnoty
-  nastavení/volba denní teploty
-  nastavení/volba snížené teploty
- P programování intervalů topení
-  nastavení denního času
- C návrat/vymazání hodnoty

Přehled údajů na displeji

- 1 aktuální denní čas
- 2 symboly
 -  regulace teploty místnosti podle zadaného programu
 -   - interval topení za snížené teploty
 -   - interval topení
 -  trvalá regulace teploty místnosti na sníženou teplotu
 -  trvalá regulace teploty místnosti podle denní teploty

- ▼ funkce "Party": až do dalšího intervalu topení za snížené teploty se teplota místnosti reguluje podle denní teploty
 - ☐ funkce "Dovolená": po dobu trvání dovolené se teplota místnosti reguluje podle nastavené teploty
 - ☛ krátkodobá změna teplota
 - 🔥 kotel dostal požadavek na teplo
- 3 aktuální teplota
 - 4 sloupcový ukazatel (I = začátek intervalu topení)

Popis přístroje

VRT 220 je prostorový regulátor teploty místnosti s denním časovým programem. Je použitelný pro všechny závěsné kotle Vaillant, stacionární kotle Vaillant a kotle jiných firem s napájením 230 V. Regulátor disponuje individuálně nastavitelným programem.

z výroby:

intervaly topení 6:00 - 22:00 hod

Volba druhu provozu	64
Aktivace funkce "dovolená"	66
Krátkodobá změna teploty	68
Nastavení denní / snížené teploty	70
Nastavení denního času	72
Nastavení programu	74
Spínání pomocí telefonního kontaktu	76

Návod k montáži

Tento přístroj smí otevřít a podle obrázků na straně 78 až 80 instalovat pouze odborník s příslušným oprávněním. Musí přitom dodržovat existující bezpečnostní předpisy.



Na vodivých kontaktech může při zasažení elektrickým proudem dojít k ohrožení života. Před jakoukoliv manipulací s přístrojem je třeba vypnout přívod proudu a zajistit jej před nechtěným zapnutím.

Za škody, které by byly způsobeny nedodržením pokynů z tohoto návodu, zvláště při nesprávném propojení nebo při mechanickém poškození, nepřebíráme záruku.

Připojení dálkového telefonního spínače (TEL)

Dálkový telefonní spínač se připojí na svorky 5 a TEL na regulátoru (viz obrázek na straně 80).

Řiďte se návodem k instalaci dálkového telefonního spínače.





Technické údaje

Označení přístroje	VRT 220
Napětí	230 V~
Příkon	< 3mA
Max. zatížení kontaktů	5 A/250 V~ $\cos \varphi=1$
Reserva chodu	0,5 h
Rozsah denní teploty	5 ... 30°C
Rozsah snížené teploty	5 ... 20°C
Diference spínání	$\leq 1K$
Přívodní vedení	3x0,75 mm ²
Druh ochrany	IP 30
Třída ochrany	II
Provozní teplota	+ 5 ... + 50 °C
Přípustná teplota skladování	- 20 ... + 65 °C
Rozměry	111 x 81 x 33 mm
Vstup TEL aktivní	230 V~







Exploatare

În camera în care amplasați termostatul deschideți toate robinetele termostatare.

Elemente de comandă

-  selectare regim de funcționare
- OK confirmare valori, derulare meniu
- + mărire valori
- micșorare valori
-  reglare/alegere temperatură de zi
-  reglare/alegere temperatură de noapte
- P Programare timpi de încălzire
-  reglare oră
- C Revenire/resetare valoare

Privire de ansamblu asupra pupitrului de comandă

- 1 Ora actuală
- 2 Simbol
 -  Termostatul va funcționa după următorul program.
 -   - Temperatură de noapte
 -   - Temperatură de zi (încălzire).
 -  O reglare continuă a temperaturii de cameră, corespunzătoare programului de diminuare.
 -  O reglare continuă a temperaturii de cameră, corespunzătoare programului de zi.

- ▼ Funcție party: până la primul program de noapte, termostatul va funcționa pe temperatura de zi.
- 🗑️ Program de vacanță: puteți regla temperatura pe durata întregului concediu.
- ➡️ Scurtă modificare a temperaturii.
- 🔥 Necesară de căldură.

3 Temperatura actuală

4 LED-uri indicatoare (I = pornire încălzire)

Descriere aparat

VRT 220 este un termostat de cameră cu programare săptămânală. Se poate monta pe toate aparatele murale și cazanele Vaillant, sau pe oricare alt aparat care are pe placa electronică un racord la 220 V.

Regulatorul dispune de un program individual.

Reglare din fabrică

Timpi de încălzire

6:00 - 22:00

Selectarea regimului de funcționare	64
Activarea funcției concediu	66
Scurtă modificare a temperaturii	68
Reglarea temperaturii de zi / noapte	70
Reglarea orei	72
Modificarea programelor	74
Cuplarea prin intermediul telefonului	76

Instalare

Aparatul poate fi deschis și montat conform instrucțiunilor de la pag. 78 - 80, numai de către persoane autorizate. În acest sens trebuie să urmăriți cu atenție instrucțiunile de siguranță.



Lucrați cu grijă la elementele sub tensiune ale aparatului. Înainte de orice intervenție la aparat, deconectați-l de la rețeaua de curent, iar la repornire asigurați-vă că totul este în ordine.

Pentru defecțiuni rezultate în urma nerespectării acestor instrucțiuni (de ex. racorduri greșite, ori deteriorări mecanice) nu ne asumăm nici o răspundere.

Racord telefonic (TEL)

Racordul telefonic se realizează la clemele 5 și TEL ale regulatorului (vezi fig. de la pag. 80).

Parcurgeți și instrucțiunile de instalare ale aparatului telefonic.





Date tehnice

Descriere aparat	VRT 220
Tensiune de lucru	230 V~
Consum de curent	< 3mA
Sarcină maximă pt. contact	5 A/250 V~ $\cos \varphi=1$
Rezervă de timp	0,5 h
Domeniu pt. temperatura de zi	5 ... 30°C
Domeniu pt. temp. de noapte	5 ... 20°C
Diferență de cuplare	$\leq 1K$
Cablu de racord	3x0,75 mm ²
Tip siguranță	IP 30
Clasă de protecție	II
Temperatură de lucru	+ 5 ... + 50 °C
Temp. de depozitare admisă	- 20 ... + 65 °C
Dimensiuni	111 x 81 x 33 mm
Intrare TEL activ:	230 V ~







Rukovanje

U prostoriji u kojoj se nalazi regulator temperature uvijek ostavite potpuno otvorene sve ventile na radiatorima.

Elementi za rukovanje

-  odabrati način rada
- OK vrijednost potvrditi, listati dalje
- + vrijednost povećati
- vrijednost smanjiti
-  podesiti / odabrati dnevnu temperaturu
-  podesiti / odabrati sniženu temperaturu
- P programirati vremena grijanja
-  podesiti vrijeme
- C vratiti se natrag / resetirati vrijednost

Pregled prikaza na displeju

- 1 aktualno vrijeme
- 2 simboli
 -  sobna temperatura se regulira preko unese-
nog programa
 -   - vrijeme snižene temperature
 -   - H vrijeme grijanja
 -  stalno reguliranje temperature u prostorija-
ma prema sniženoj temperaturi
 -  stalno reguliranje temperature u prostorija-
ma prema dnevnoj temperaturi

- ▼ funkcija "party": do slijedećeg vremena snižene temperature će se temperatura u prostorijama regulirati prema dnevnoj temperaturi
 - 📅 program godišnjeg odmora: tijekom godišnjeg odmora će se temperatura u prostorijama regulirati prema podešenoj temperaturi
 - 👉 kratkotrajna promjena temperature
 - 🔥 poreba za toplinom
- 3 aktualna temperatura
 - 4 linijski prikaz (I = vrijeme grijanja uključeno)

Opis uređaja

VRT 220 je regulator temperature u prostorijama s dnevnim programom grijanja. On se može koristiti za sve Vaillantove zidne uređaje (osim VHR NL), Vaillantove kotlove i uređaje drugih proizvođača s međusklopom 230 V.

Regulator raspolaže s jednim individualno podešivim programom.

Tvornička podeš. :

Vremena grijanja

6:00 - 22:00 sati

Odabrati način rada	64
Aktivirati funkciju godišnjeg odmora	66
Kratkotrajno promijeniti temperaturu	68
Podesiti dnevnu temperaturu	70
Podesiti sniženu temperaturu	70
Podesiti vrijeme	72
Podesiti program	74
Upravljanje preko daljinske telefonske sklopke	76

Montaža

Uređaj smije otvoriti i prema slikama na stranicama od 78 do 80 instalirati samo ovlašteni stručnjak. Pritom se treba pridržavati postojećih propisa o sigurnosti.



Opasnost po život uslijed strujnog udara iz priključaka koji su pod naponom. Prije radova na uređaju treba isključiti dovod struje i osigurati se da ne dođe do ponovnog uključivanja.

Ne preuzimamo odgovornost za štete koje bi nastale uslijed nepridržavanja ovih uputa, a posebice za one nastale uslijed pogrešnog ožičenja ili mehaničkog oštećenja.

Priključivanje daljinske telefonske sklopke (TEL)

Daljinska telefonska sklopka se priključuje na stezaljke regulatora 5 i TEL (vidi sliku na stranici 80). Pridržavajte se uputa za instaliranje daljinske telefonske sklopke.





Tehnički podaci

Oznaka uređaja	VRT 220
Pogonski napon	230 V~
Primljena struja	< 3mA
Maks. opterećenje kontakta	5 A/250 V~ $\cos \varphi=1$
Hodna reserva	0,5 h
Područje dnevne temperature	5 ... 30°C
Područje noćne temperature	5 ... 20°C
Uklopna razlika	$\leq 1K$
Priključni vodovi	3x0,75 mm ²
Vrsta zaštite	IP 30
Klasa zaštite	II
Pogonska temperatura	+ 5 ... + 50 °C
Dozvoljena temperatura skladištenja	- 20 ... + 65 °C
Dimenzije	111 x 81 x 33 mm
Ulaz telefon aktiv:	230 V ~







Obsluha

V miestnosti, v ktorej sa nachádza regulátor vnútornej teploty nechajte, vždy na vykurovacích telesách otvorené všetky ventily.

Obslužné prvky

-  Voľba prevádzkového režimu
- OK Potvrdenie hodnoty, ďalšie listovanie
- + Zvýšenie hodnoty
- Zníženie hodnoty
-  Nastavenie / voľba dennej teploty
-  Nastavenie / voľba zníženej teploty
- P Programovanie vykurovacích dôb
-  nastavenie dňa v týždni a času
- C Krok späť / návrat hodnoty

Prehľad symbolov displeja

- 1 Aktuálny čas
- 2 Symboly
 -  Teplota v miestnosti sa riadi zadaným programom.
 -   - Znížená teplota
 -   - Doba vykurovania
 -  Stála regulácia teploty v miestnosti v závislosti od zníženej teploty.
 -  Stála regulácia teploty v miestnosti v závislosti od dennej teploty

▼ Funkcia "Party": až k nasledujúcemu času zníženia sa teplota v miestnosti reguluje v závislosti od dennej teploty.

🗄️ Dovolenkový program: Počas trvania Vašej dovolenky sa teplota v miestnosti riadi adekvátne nastavenou teplotou.

👉 Krátkodobá zmena teploty.

🔥 Požiadavka tepla na vykurovacie zariadenie

3 Aktuálna teplota

4 Zobrazenie kurzora (I = Čas vykurovania zapnutý)

Popis zariadenia

VRT 220 je regulátor vnútornej teploty s denným vykurovacím programom. Je možné ho použiť pre všetky nástenné vykurovacie zariadenia Vaillant (okrem VHR NL), vykurovací kotol Vaillant a cudzie zariadenia s rozhraním 230 V.

Regulátor disponuje dvoma individuálne nastaviteľným programom.

Vo výr. Závode:

Vykurovacie doby

6: 00- 22: 00 hod.

Voľba typu prevádzky	64
Krátkodobé prestavenie teploty	66
Aktivácia dovolenkovej funkcie	68
Nastavenie dennej / zníženej teploty	70
Nastavenie dňa	72
Nastavenie programu	74
Zapnutie prostredníctvom telefonického kontaktu	76

Montáž

Toto zariadenie smie otvoriť len vyškolený odborník a inštalovať v súlade s vyobrazeniami na stranách 78 až 80. Pritom je potrebné dodržiavať nasledujúce bezpečnostné predpisy.



Ohrozenie života úderom elektrického prúdu na prívodných častiach vedúcich elektrické napätie. Pred prácami na zariadení je potrebné odpojiť ho od prívodu elektrickej energie a zaistiť pred opätovným zapnutím.

Za škody vzniknuté v dôsledku nerešpektovania tohto návodu, zvlášť v dôsledku nesprávneho pripojenia vodičov alebo mechanického poškodenia, nepreberáme žiadnu záruku.

Pripojenie telefónneho diaľkového spínača (TEL)

Telefonický diaľkový spínač sa pripojí na svorky 5 a TEL regulátora (pozri vyobrazenie na strane 80). Rešpektujte prosím návod na inštaláciu telefónneho diaľkového spínača.

Technické údaje

Označenie zariadenia	VRT 220
Prevádzkové napätie	230 V~
Odber prúdu	< 3mA
Zaťaženie max	5 A/250 V~ $\cos \varphi=1$
Rezerva chodu	0,5 h
Rozsah dennej teploty	5 ... 30°C
Rozsah zníženej teploty	5 ... 20°C
Diferencia zapojenia	$\leq 1K$
Prípojné vedenia	3x0,75 mm ²
Spôsob ochrany	IP 30
Trieda ochrany	II
Prevádzková teplota	+ 5 ... + 50 °C
Príp. teplota skladovania	- 20 ... + 65 °C
Rozmery	111 x 81 x 33 mm
Vstup TEL aktívny:	230 V ~

Kullanım

Oda termostatınızın bulunduğu odadaki radyatör vanalarını daima sonuna kadar açık tutunuz.

Kumanda elemanları

☰ İşletme türü seçimi

OK Seçilen değeri onaylama, devam etme

+ Değeri yükseltme

- Değeri azaltma

☀ Gündüz konumu sıcaklık ayarı / seçimi

🌙 Gece konumu sıcaklık ayarı / seçimi

P Isıtma zamanlarını programlama

🕒 Aktüel saat ve gün ayarı

C Geri dönüş/değeri silmek

Ekran, genel görünüm

1 Aktüel saat

2 Semboller

🕒 Oda sıcaklığı ayarlanmış bir programa göre düzenlenir.

🕒 🌙 - Program-gece konumunda

🕒 ☀ - Program-gündüz konumunda

🌙 Oda sıcaklığının, sürekli olarak seçilen gece konumu sıcaklığına göre ayarlanması

☀ Oda sıcaklığının, sürekli olarak seçilen gündüz konumu sıcaklığına göre ayarlanması

- ▼ Parti fonksiyonu: Bir sonraki gece konumu zamanına kadar, oda sıcaklığı seçilen gündüz konumu sıcaklığına göre ayarlanmaktadır.
 - ☑ Tatil programı:Tatiliniz boyunca oda sıcaklığınız, seçtiğiniz sıcaklıklara göre ayarlanacaktır.
 - ➡ Kısa süre için sıcaklık değiştirilmesi
 - 🔥 Kalorifer konumunda ısı talebi
- 3 Aktüel oda sıcaklığı
 - 4 Gösterge (I=Program ısıtma zamanı başlangıcı)
 - 5 Günler

Cihazın tarifi

VRT 220, günlük ısıtma programı olan bir oda termostatıdır. Vaillant'ın bütün duvar tipi cihazlarıyla, Vaillant kazanları ve 230 V'luk regler bağlantı yeri olan yabancı cihazlarla el kullanılabılır.

Fabrika ayarı

Isıtma saatleri

Saat 6.00-22.00

İşletme türü seçimi	64
Tatil fonksiyonunu çalıştırma	66
Kısa süre için sıcaklık değiştirilmesi	68
Gündüz konumu sıcaklığının ayarlanması	70
Gece konumu sıcaklığının ayarlanması	70
Aktüel saat ve günün ayarlanması	72
Ana program seçimi	74
Telefon bağlantısıyla kumanda	76

Montaj

Uzaktan kumandalı oda termostatının montajı

Bu cihaz sadece Vaillant teknik servis elemanları tarafından çalıştırılabilir ve 78 ile 80 sayfalardaki şekillerde gösterilen talimatlara uymak suretiyle Vaillant yetkili satıcıları tarafından monte edilebilir. Bu işlemler sırasında emniyet talimatlarına dikkat edilmelidir.



Elektrik gerilimi yüklü bağlantılardan elektrik çarpması sonucu hayati tehlike mevcuttur. Cihaz üzerinde çalışmaya bağlamadan önce elektrik girişini kesiniz ve tekrar açılmamasını emniyet altına alınız.

Bu montaj kılavuzundaki talimatlara uyulmaması nedeniyle oluşabilecek, özellikle hatalı kablo bağlantısından veya mekanik arızalardan meydana gelebilecek, hasarlar için sorumluluk üstlenmemekteyiz.

Telefonla uzaktan kumanda bağlantısı (TEL)





Telefonla uzaktan kumanda cihazı oda termostatu üzerindeki 5 ve TEL klemenslerine bağlanacaktır (bkz. Şekil Sayfa 80). Telefonla uzaktan kumanda cihazının montaj kılavuzundaki talimatlara dikkat ediniz.

Teknik veriler







Cihaz tipi	VRT 220
İşletme gerilimi	230 V~
Çekilen akım	< 3 mA
Max. kontak yükü	5 A/250 V~ cos φ=1
Çalışma rezervi (saat)	0,5 h
Gündüz konumu sıcaklık ayar aralığı	5 ... 30°C
Gece konumu sıcaklık ayar aralığı	5 ... 20°C
Devreye girme sıcaklık farkı	≤ 1K
Bağlantı kabloları	3x0,75 mm ²
Koruma türü	IP 30
Koruma sınıfı	II
İşletme sıcaklığı	+ 5 ... + 50 °C
Müsaade edilen depolama sıcaklığı	- 20 ... + 65 °C
Ölçüleri	111x81x33
Giriş TEL aktif:	230 V~

В помещении, где находится комнатный термостат, должны быть полностью открыты или сняты все термостатические вентили на отопительных приборах.

Кнопки на панели управления

-  Выбор режима работы
- OK Сохранить данные, пролистать меню
- + Увеличение значения
- Уменьшение значения
-  Выбор / установка дневной температуры помещения
-  Выбор / установка ночной температуры помещения
- P Задание отрезков времени для программы
-  Установка времени
- C Возврат назад / отказ от изменения

Элементы дисплея

- 1 Текущее время
- 2 Символы
 -  Температура помещения изменяется по заданной программе.
 -   - Ночной режим
 -   - Дневной режим
 -  Постоянное поддержание заданной ночной температуры
 -  Постоянное поддержание заданной дневной температуры

 Функция "Встреча": До следующего интервала отопления с ночной температурой помещения поддерживается дневная температура.

 Программа "Отпуск": Во время Вашего отпуска поддерживается специально заданная для этого температура помещения.

 Кратковременное изменение температуры

 Передаётся запрос теплоты на котёл

3 Фактическая температура

4 Столбчатый индикатор (I=дневной режим)

Описание прибора

VRT 220 является комнатным термостатом с программированием на сутки. Он применяется для всех настенных котлов Vaillant (кроме VU 506), напольных котлов Vaillant и аппаратов других производителей с возможностью управления через цепи 220 В.

Временные отрезки

6:00-22:00 час

Выбор режима работы	64
Включение программы "Отпуск"	66
Кратковременная перестановка температуры	68
Установка дневной температуры	70
Установка ночной температуры	70
Установка времени	72
Задание программ	74
Управление через телефонный контактор	76

Монтаж

Этот прибор должен открываться и монтироваться только лицензированным специалистом в соответствии с рисунками на стр.78...80. При этом должны соблюдаться действующие местные нормы и предписания, касающиеся монтажа и эксплуатации электрооборудования.



Опасность поражения электротоком при прикосновении к токоведущим частям!
Перед началом работ отключите установку от электросети и защитите её от несанкционированного включения.

За повреждения и ущерб, вызванные несоблюдением данной инструкции, в том числе из-за ошибочного подключения и механических повреждений, завод-изготовитель ответственности не несёт.

Подключение телефонного контактора

Телефонный контактор подключается к клеммат 5 и TEL термостата (См. рис. на стр. 80). Просьба соблюдать инструкции по монтажу телефонного контактора.

Технические данные

Обозначение прибора	VRT 220
Напряжение питания	230 V~
Ток контактов	< 3mA
Максимальный ток контактов:	5 A/250 V~ cos φ=1
Запас хода	0,5 ч
Диапазон дневных температур помещения	5 ... 30°C
Диапазон ночных температур помещения	5 ... 20°C
Зона нечувствительности	≤ 1K
Подключаемые проводники	3x0,75 mm ²
Вид защиты	IP 30
Класс защиты	II
Температура эксплуатации	+ 5 ... + 50 °C
Допустимая температура хранения	- 20 ... + 65 °C
Размеры	111 x 81 x 33 mm

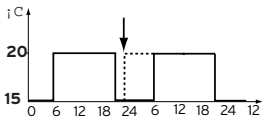
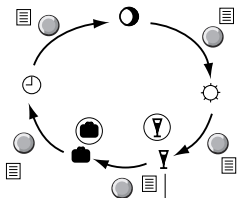

DE	Betriebsart wählen
GB	Choose the operating mode
FR	Choix du mode de fonctionnement
ES	Seleccionar modo de funcionamiento
IT	scegliere il modo operativo
NL	Bedrijfsfunctie kiezen
DK	Valg af driftsart
PL	Wybór trybu pracy
HU	Üzem mód kiválasztása
CZ	Volba druhu provozu
RO	Selectarea regimului de funcționare
HR	Odabirati način rada
SK	Voľba prevádzkového režimu
TR	İşletme türü seçimi
RUS	Выбор режима работы

①

4x

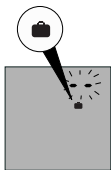

+



②

OK



+



③

OK



DE	Urlaubsfunksions aktivieren
GB	Activate the holiday program
FR	Activer la fonction congés
ES	Activar funcionamiento en vacaciones
IT	attivare la funzione ferie
NL	Vakantieprogramma activeren
DK	Aktivering af feriedrift
PL	Aktywacja funkcji urlopowej
HU	Szabadság-funkciók aktiválása
CZ	Aktivace funkce "dovolená"
RO	Activarea funcției concediu
HR	Aktivirati funkciju godišnjeg odmora
SK	Aktivácia dovolenkovej funkcie
TR	Tatil fonksiyonunu çalıştırma
RUS	Включение программы "Отпуск"

①



②a

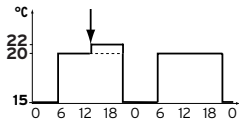

②b

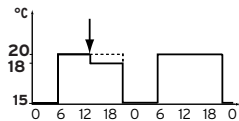

③



DE	Temperatur kurzfristig verstellen
GB	Temporary change of temperature setting
FR	Brève modification de la température
ES	Variar temperatura a corto plazo
IT	variare immediatamente la temperatura
NL	Kamertemperatuur kortstondig wijzigen
DK	Midlertidig ændring af temperatur
PL	Krótkotrwałe przestawienie temperatury
HU	Hőmérséklet módosítása rövid időre
CZ	Krátkodobá změna teploty
RO	Scurtă modificare a temperaturii
HR	Kratkotrajno promijeniti temperaturu
SK	Krátkodobé prestavenie teploty
TR	Kısa süre için sıcaklık değiştirilmesi
RUS	Кратковременная перестановка температуры

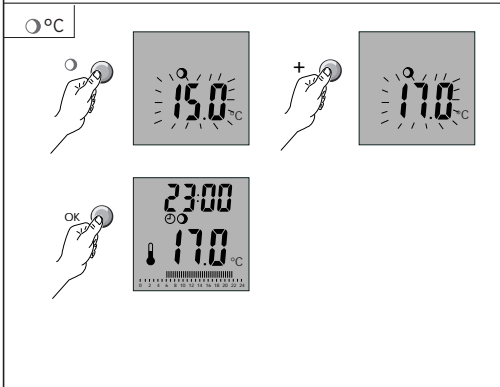
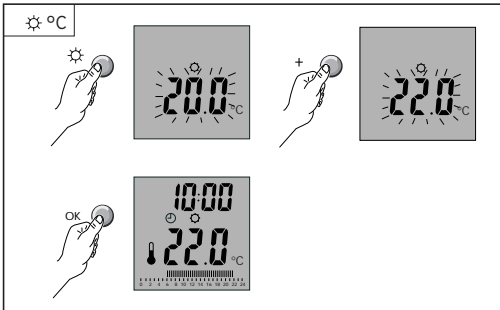

DE	Tag-/Absenkttemperatur einstellen
GB	Adjust the day / night temperature
FR	Réglage température jour / d'abaissement
ES	Ajustar temperatura diurna / descenso de temperatura
IT	impostare la temperatura diurna/attenuata
NL	Dagtemperatuur / Verlagingstemperatuur instellen
DK	Indstilling af dagtemperatur/nattemperatur
PL	Ustawienie temperatury dziennej/obniżonej
HU	Nappali hőmérséklet beállítása Csökkentett hőmérséklet" beállítása
CZ	Nastavení denní / snížené teploty
RO	Reglarea temperaturii de zi / noapte
HR	Podesiti dnevnu / sniženu temperaturu
SK	Nastavenie dennej / zníženej teploty
TR	Gündüz konumu sıcaklığının ayarlanması Gece konumu sıcaklığının ayarlanması
RUS	Установка дневной температуры Установка ночной температуры

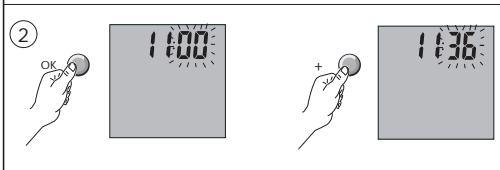
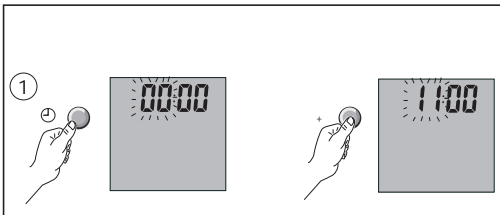

DE	Uhrzeit einstellen
GB	Set the time
FR	Réglage heure
ES	Ajustar el tiempo horario
IT	inserire ora e giorno della settimana
NL	Tijd instellen
DK	Indstilling af klokkeslæt
PL	Ustawienie godziny
HU	A pontos idő beállítása
CZ	Nastavení denního času
RO	Reglarea orei
HR	Podesiti vrijeme
SK	Nastavenie dňa
TR	Aktüel saat ve günün ayarlanması
RUS	Установка времени

①



②



5:30 = 11x



9:00 = 7x

③



19:00 = 20x



22:00 = 6x

④



DE	Programm einstellen
GB	Set program
FR	Réglage programme
ES	Ajustar programa
IT	impostare il programma
NL	Programma's P3 en Pi instellen
DK	Indstilling af program
PL	Ustawienie programu
HU	Program beállítása
CZ	Nastavení programu
RO	Modificarea programelor
HR	Podesiti program
SK	Nastavenie programu
TR	Ana program seçimi
RUS	Задание программ

①



②

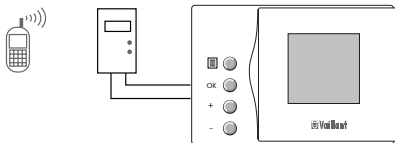

③



DE	Schalten über Telefonkontakt
GB	Connect with remote-control switch (not currently available in the UK)
FR	Enclenchement par téléphone
ES	Conectar por contacto telefónico
IT	inserire il comando telefonico a distanza
NL	Inschakelen op afstand via de telefoon (n.v.t. in NL)
DK	Styring via telefon
PL	Przełączenie przez telefon
HU	Kapcsolás telefonkapcsolaton át
CZ	Spínání pomocí telefonního kontaktu
RO	Cuplarea prin intermediul telefonului
HR	Upravljanje preko daljinske telefonske sklopke
SK	Zapnutie prostredníctvom telefonického kontaktu
TR	Telefon bağılantısıyla kumanda
RUS	Управление через телефонный контактор

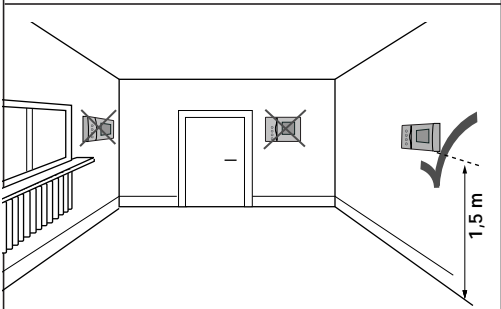
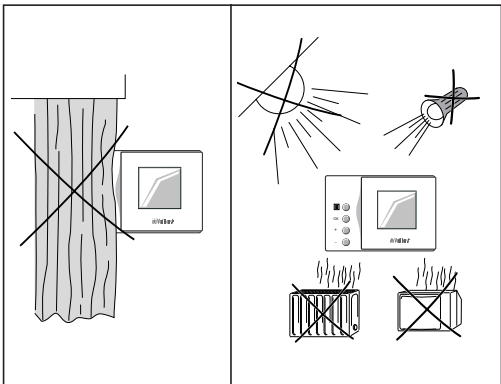

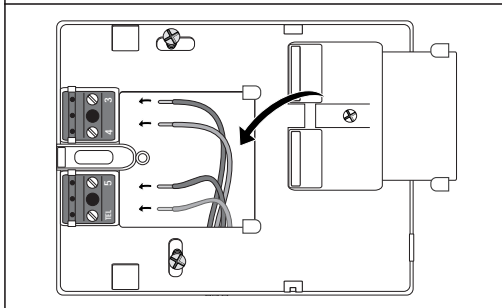
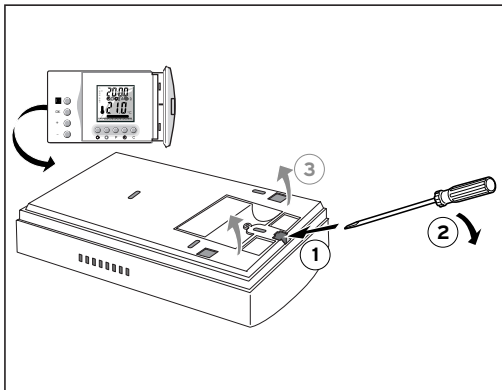

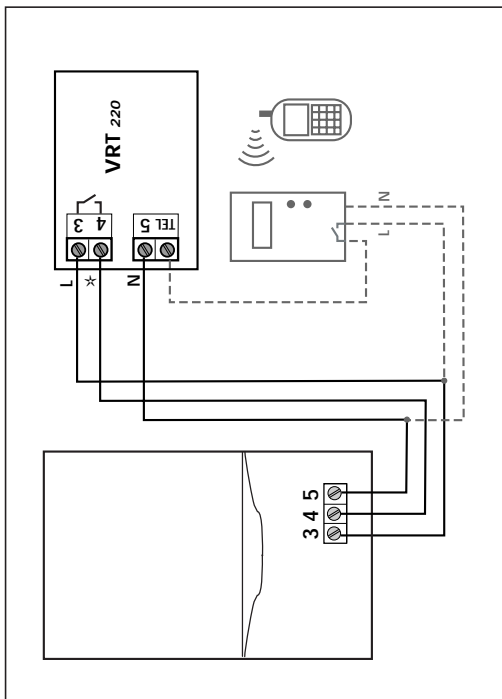

Vaillant GmbH

Berghauser Str. 40 ■ 42859 Remscheid ■ Telefon 0 21 91/ 18-0
Telefax 0 21 91/ 18-28 10 ■ www.vaillant.de ■ info@vaillant.de

83 46 77 INT 01 11/2001 V Änderungen vorbehalten